

1. Gabinet lekarski

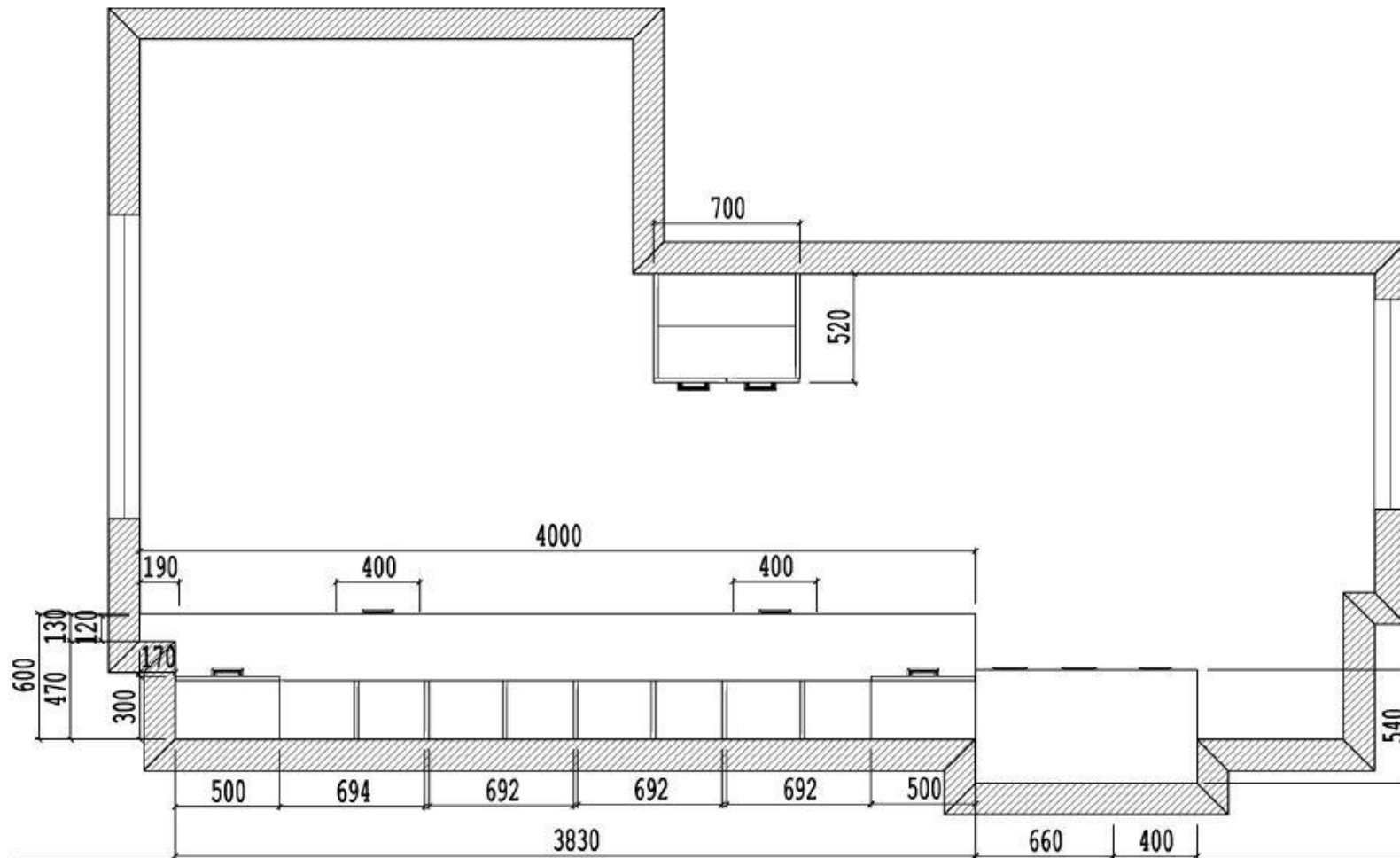

Rys.1

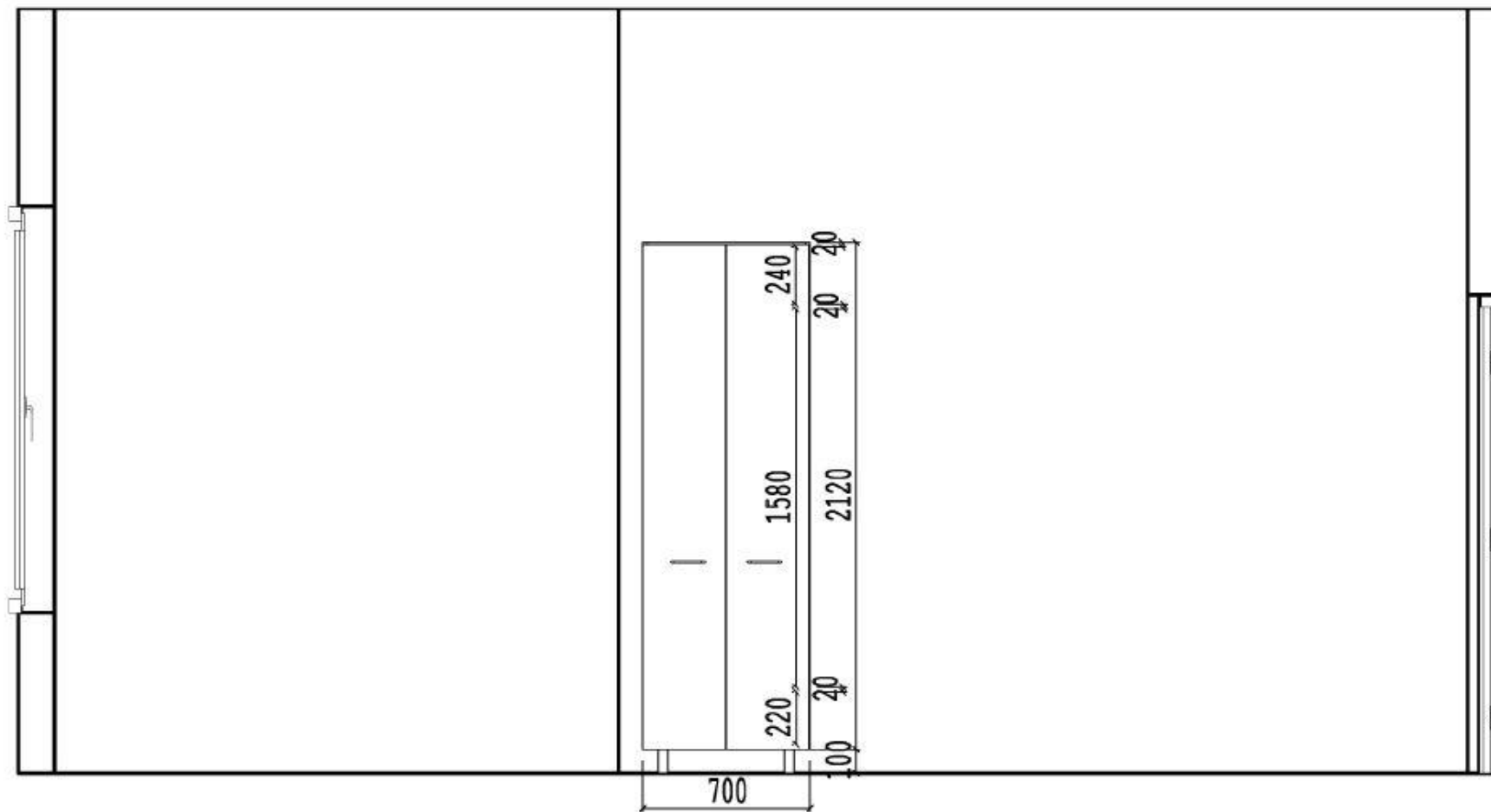

Rys.2

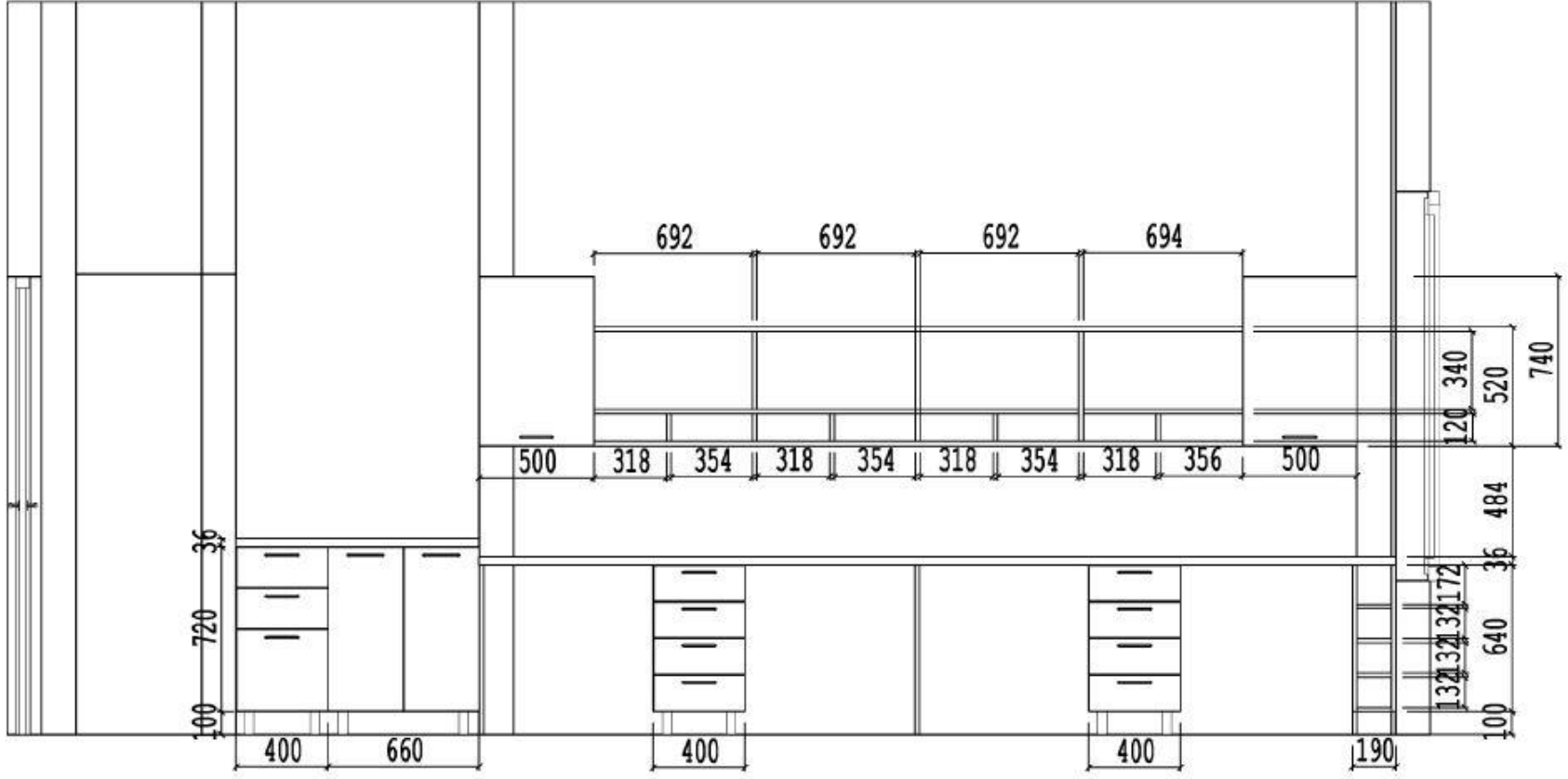

Rys.3

2. Gabinet ordynatora

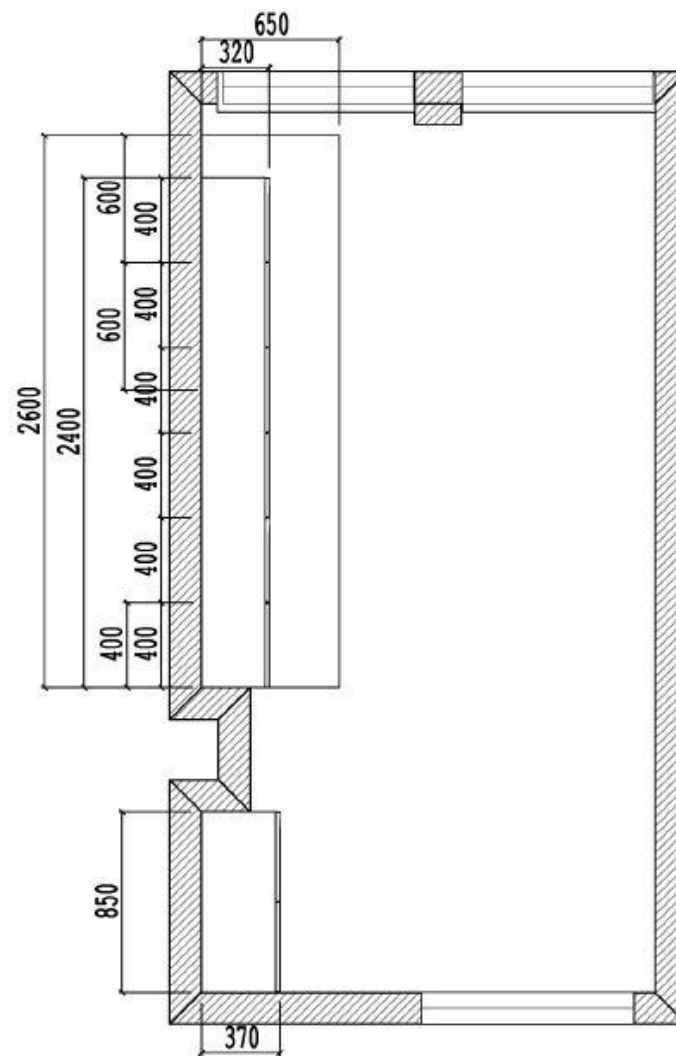

Rys.4

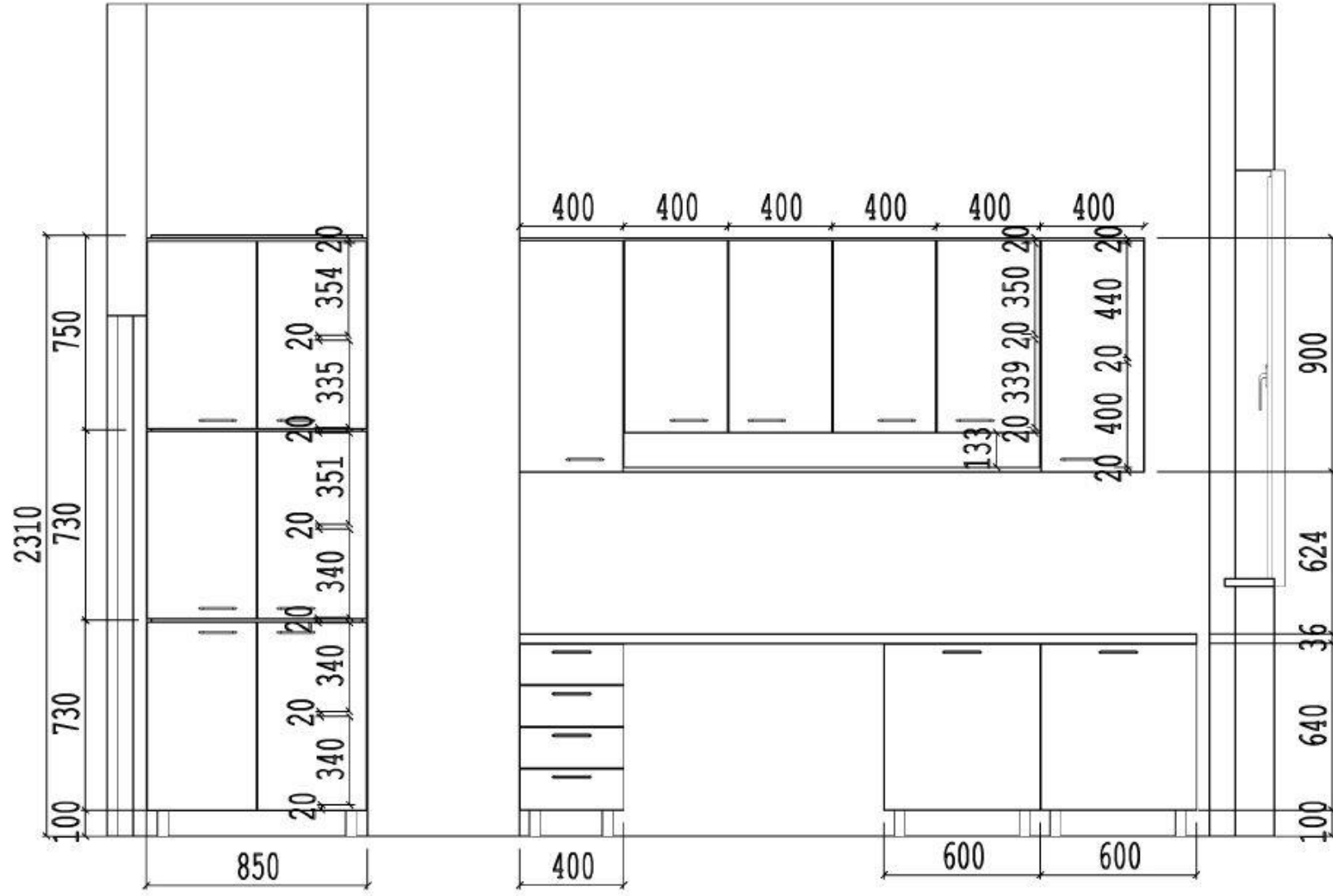

Rys.5

3. Gabinet zabiegowy

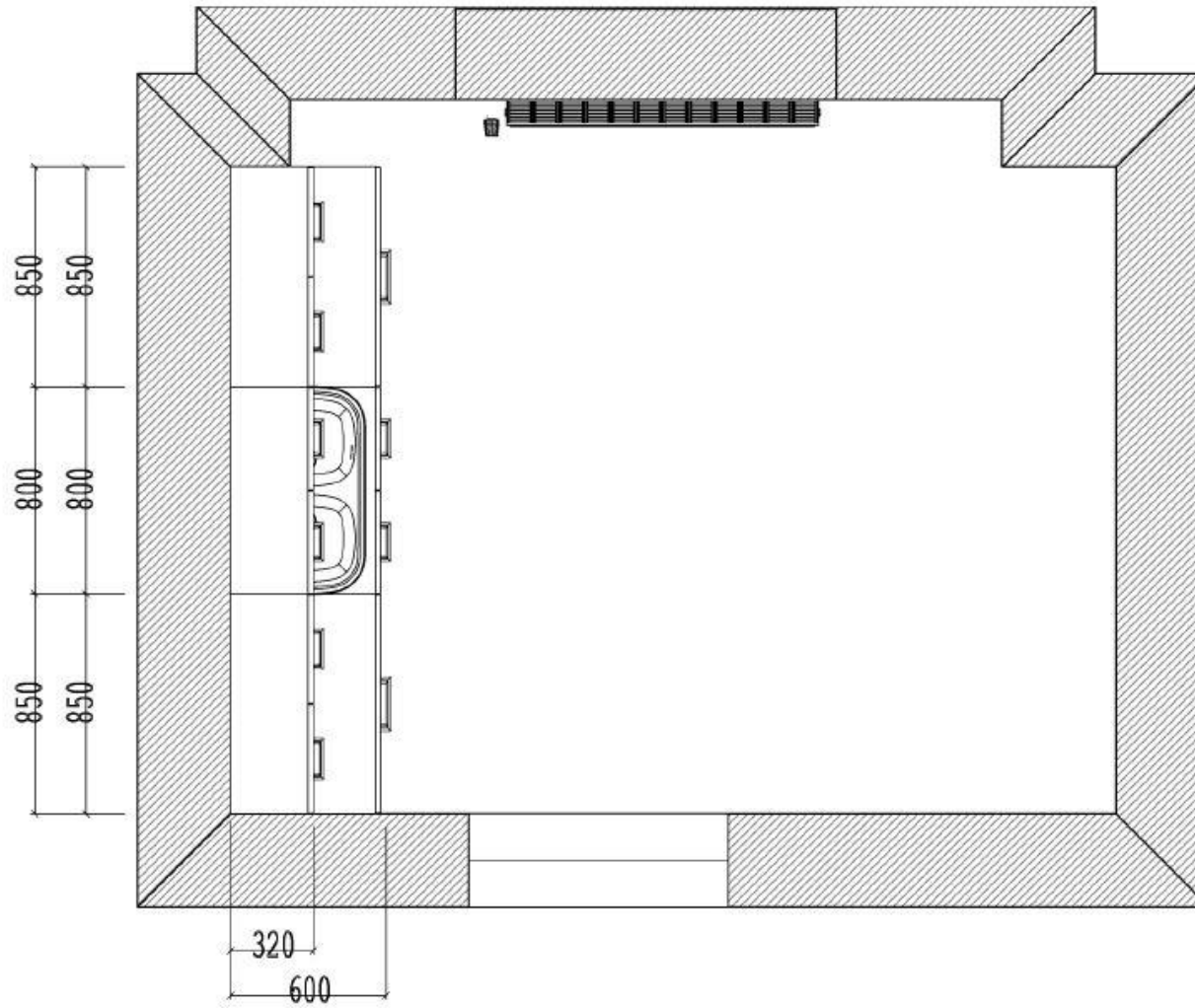

Rys.6

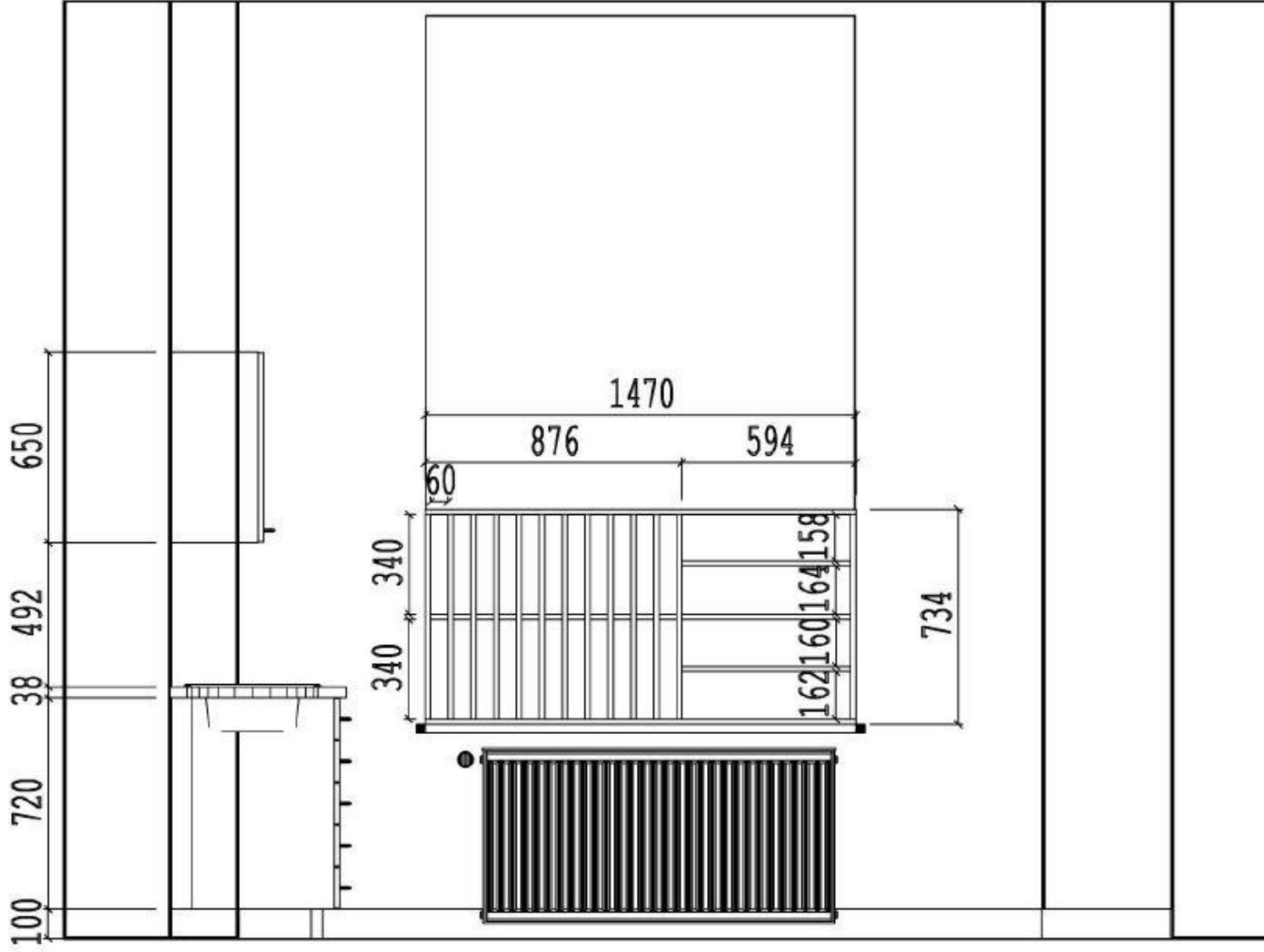

Rys.7

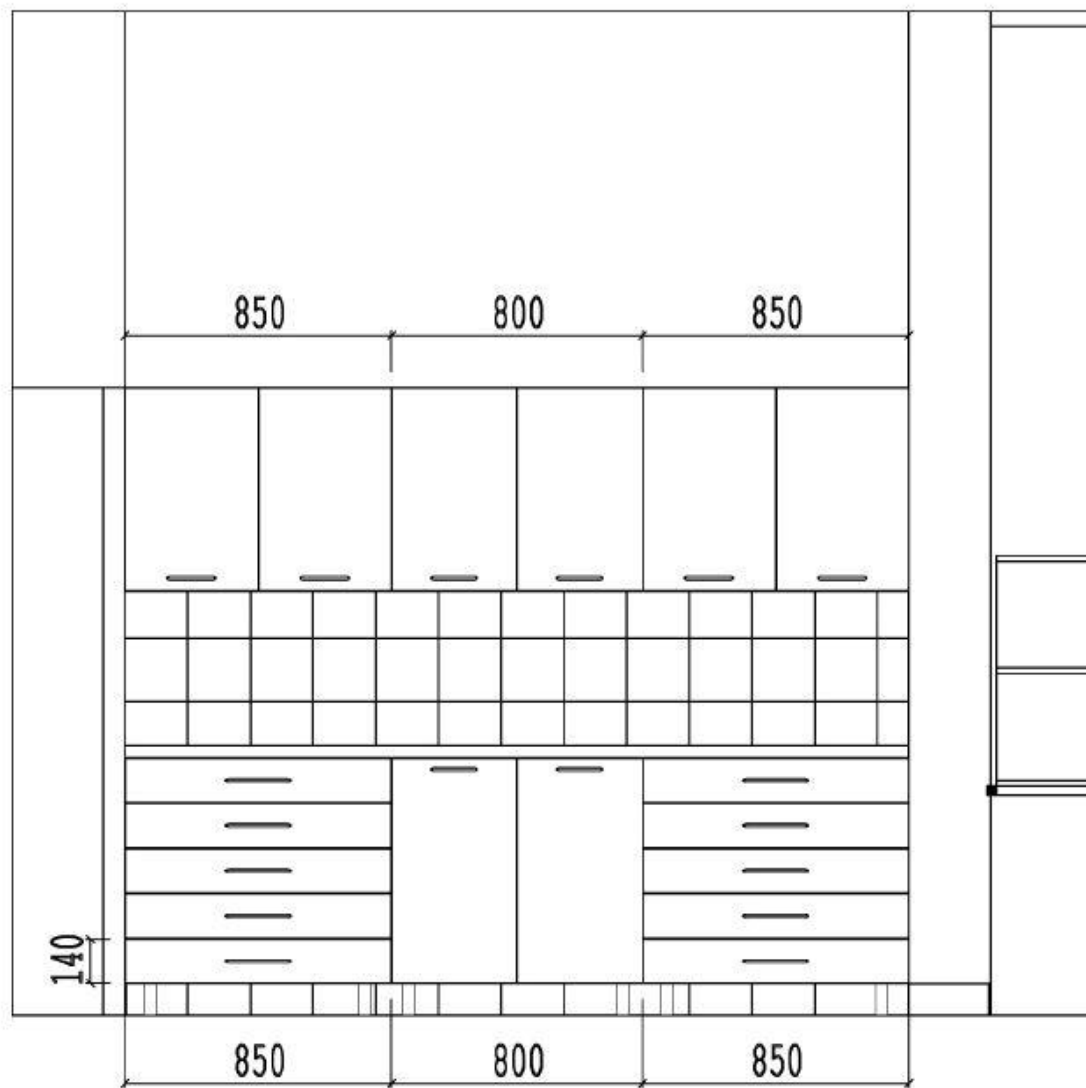

Rys.8

4. Pokój dla rodziców/pokój mleczny

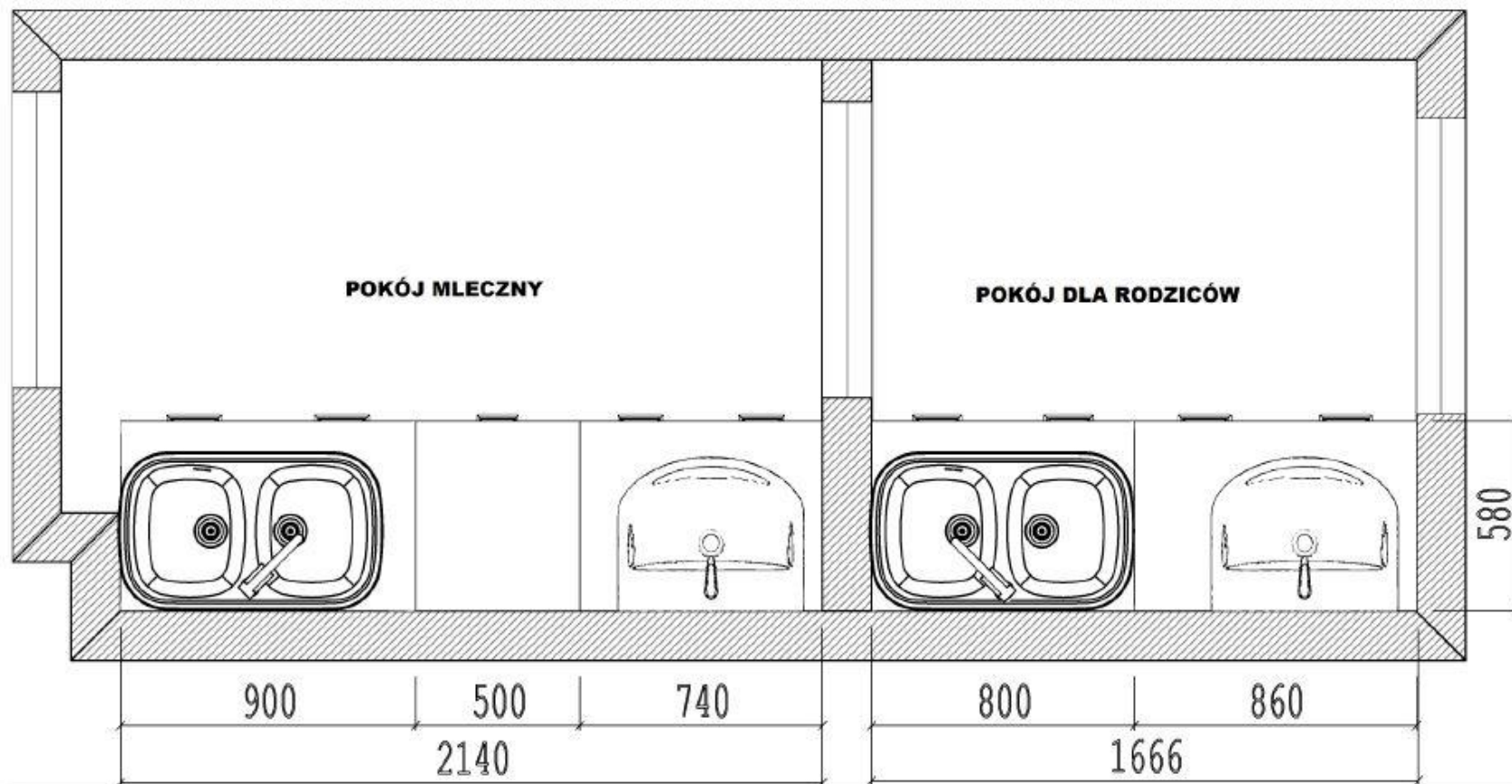

Rys.9

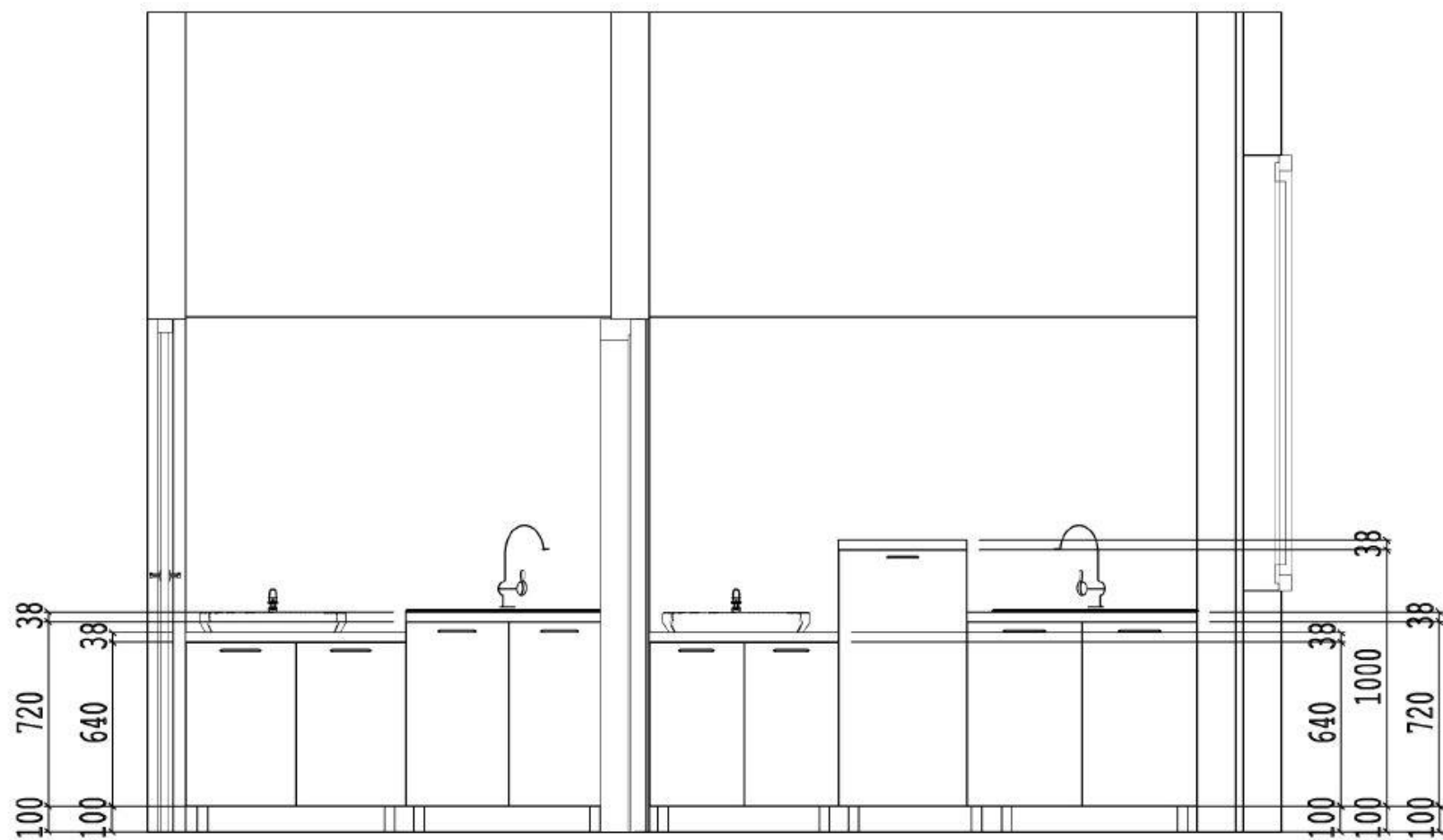

Rys.10

5. Pokój do przechowywania żywności 1

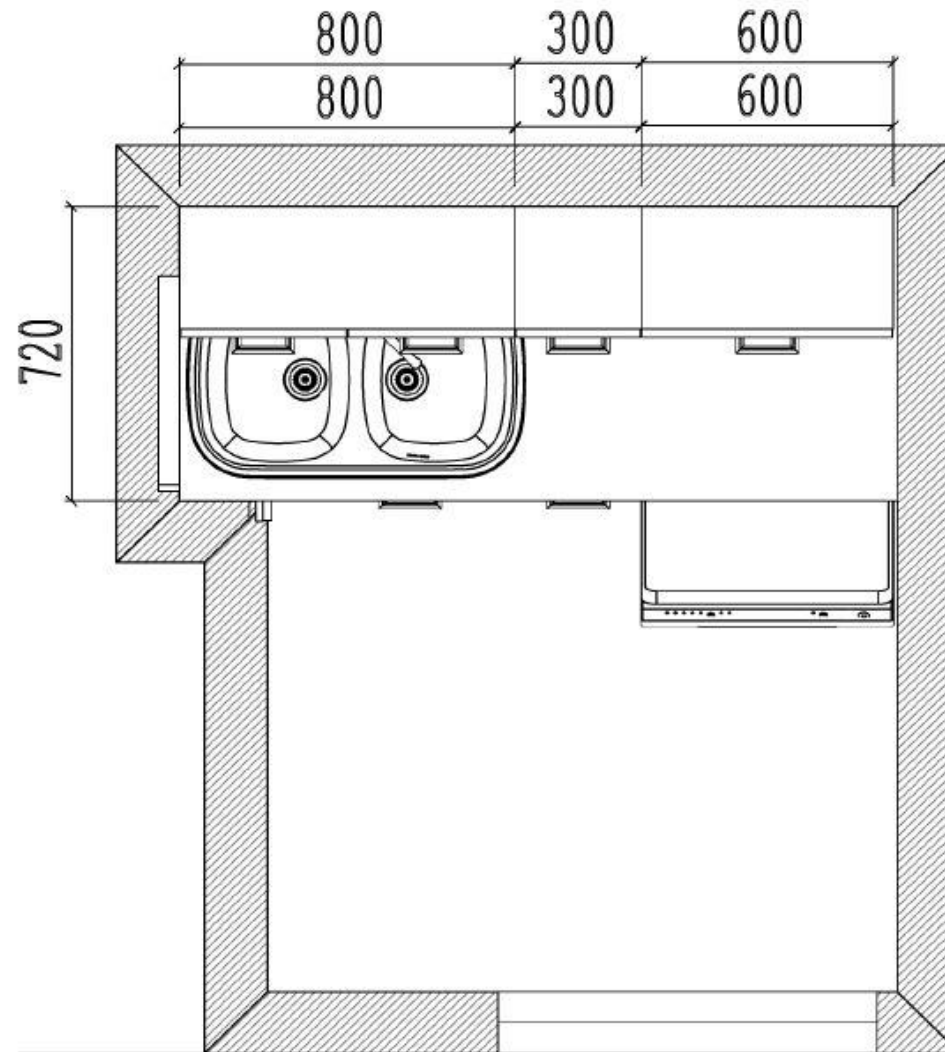

Rys.11

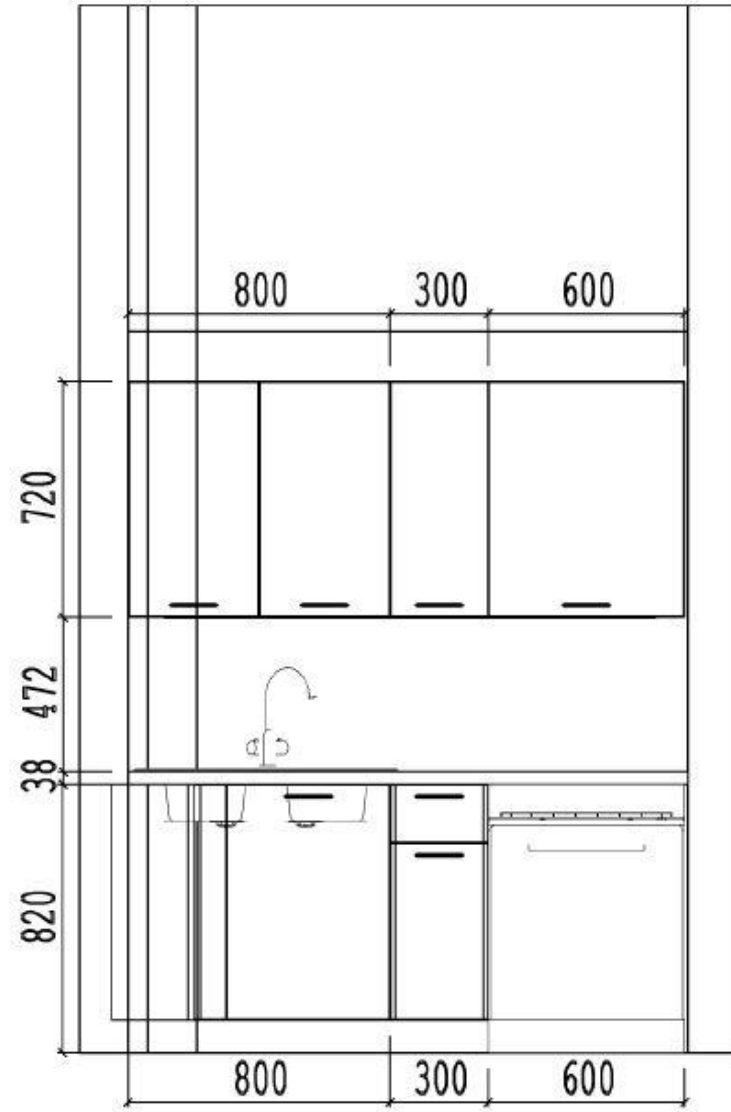

Rys.12

6. Pokój do przechowywania żywności 2

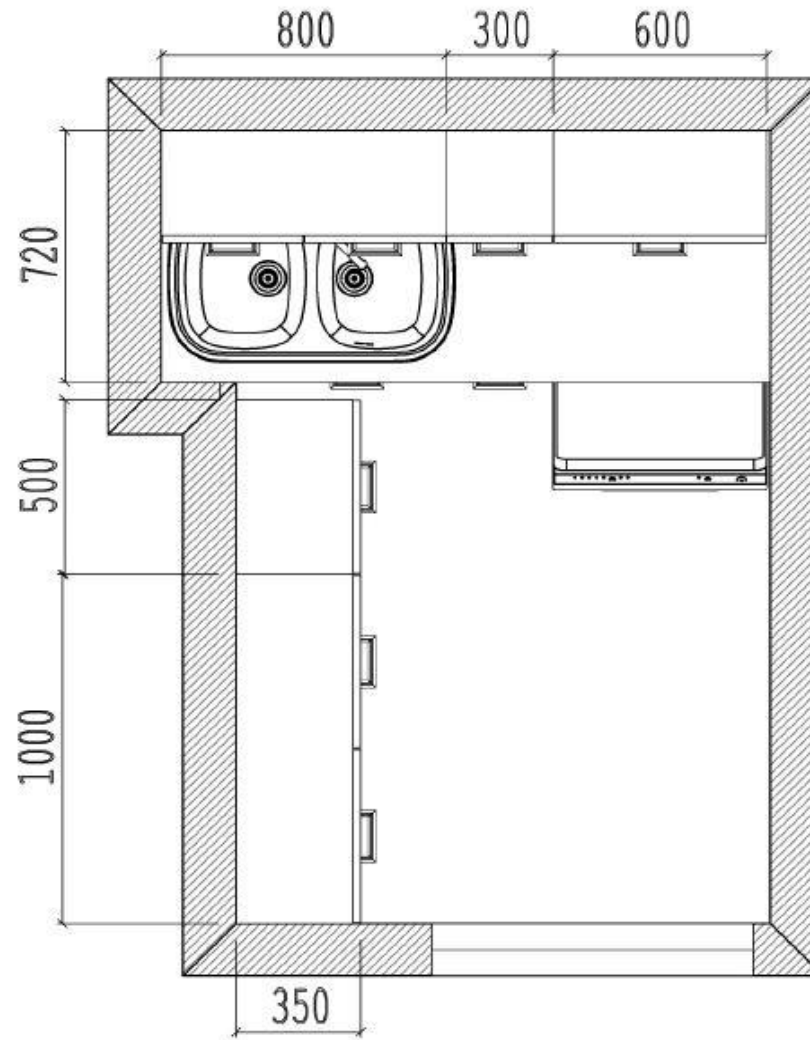

Rys.13

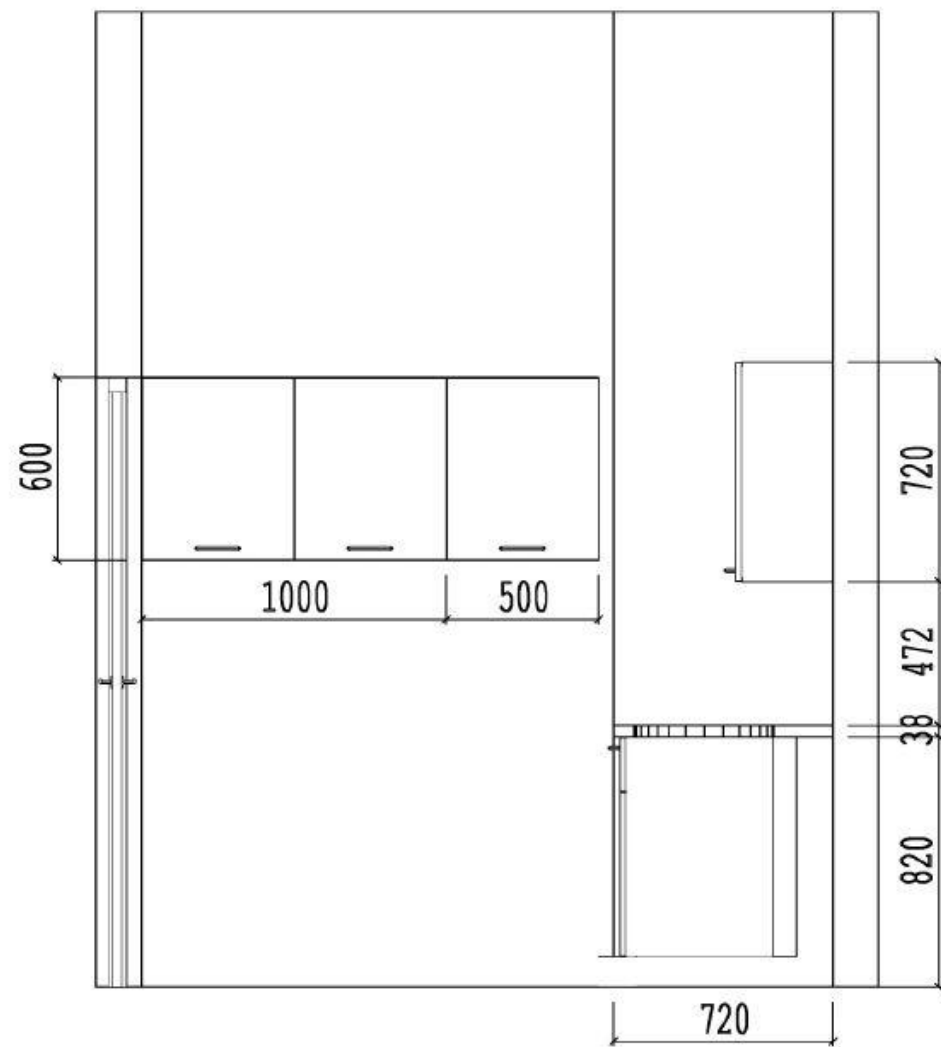

Rys.14

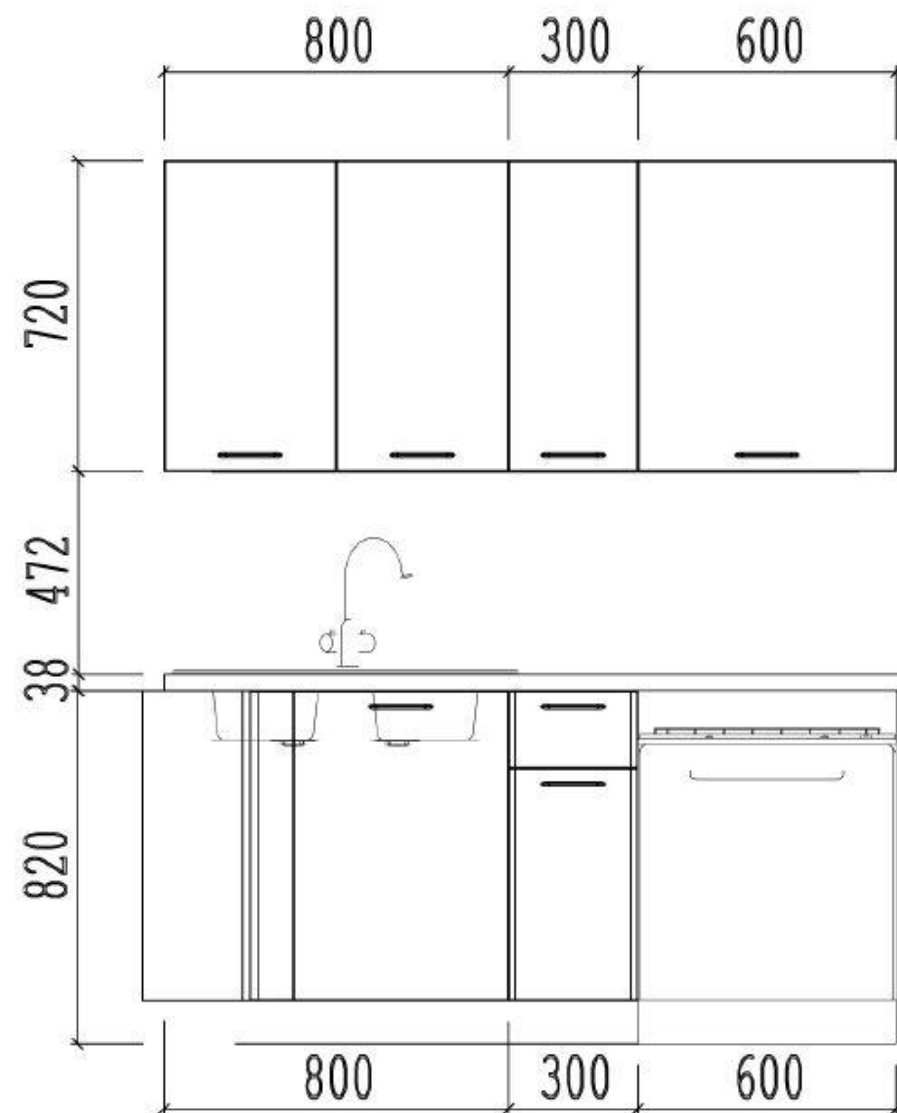

Rys.15

7. Pokój socjalny

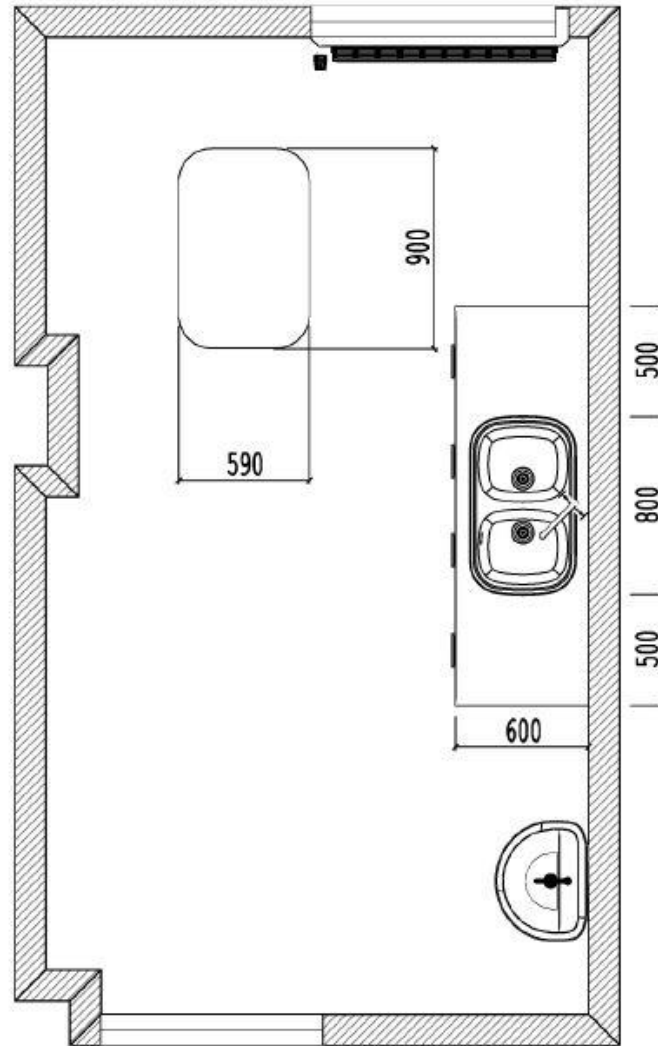

Rys.16

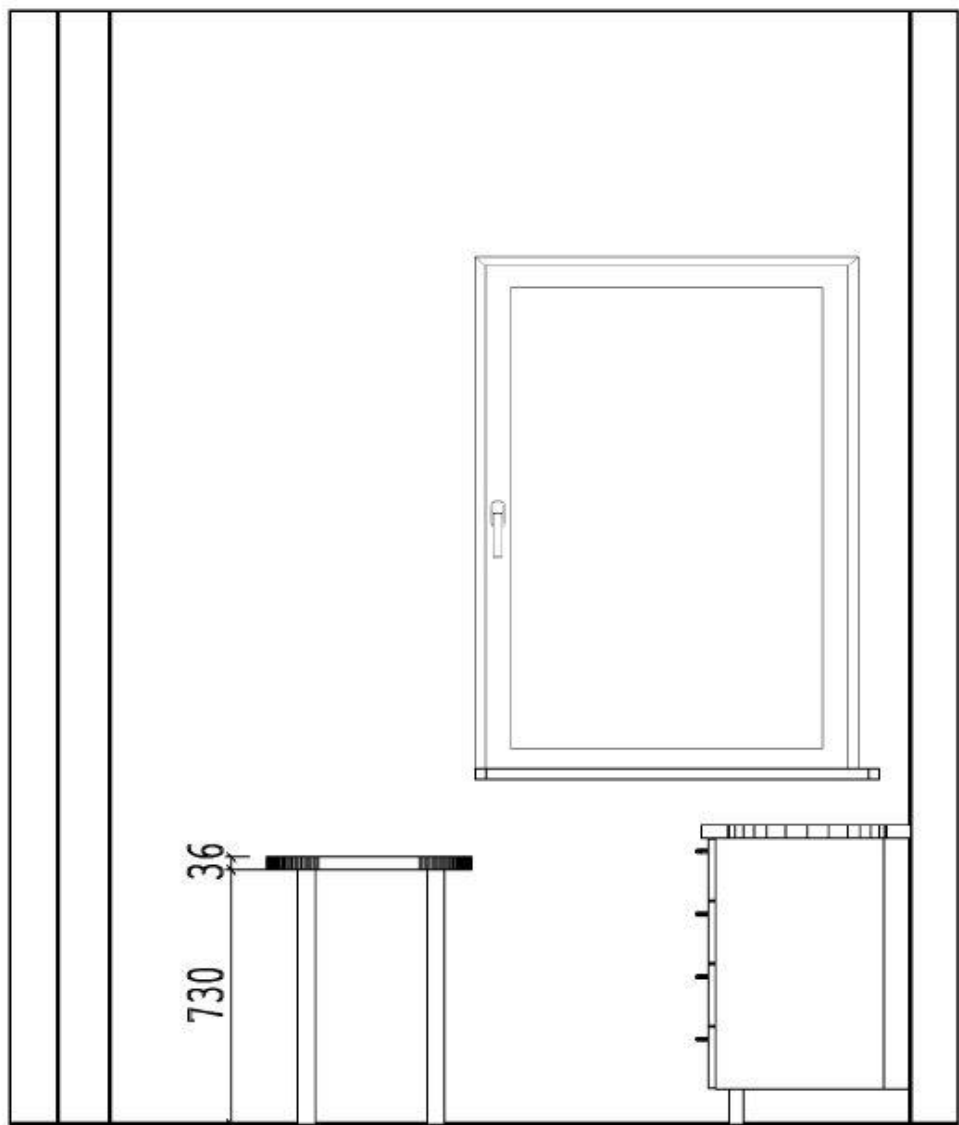

Rys.17

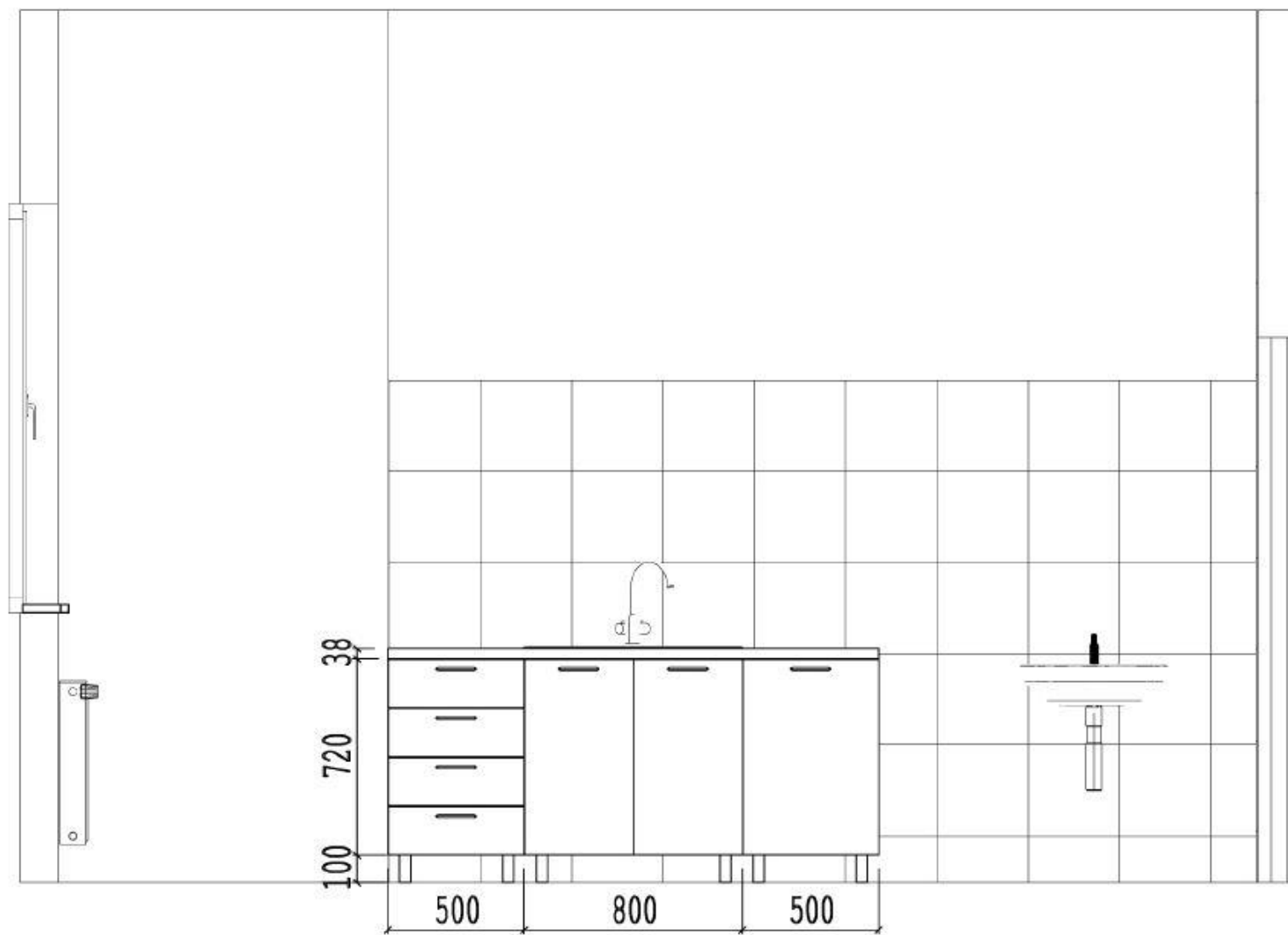

Rys.18

8. Punkt pielęgniarski i gabinet zabiegowy

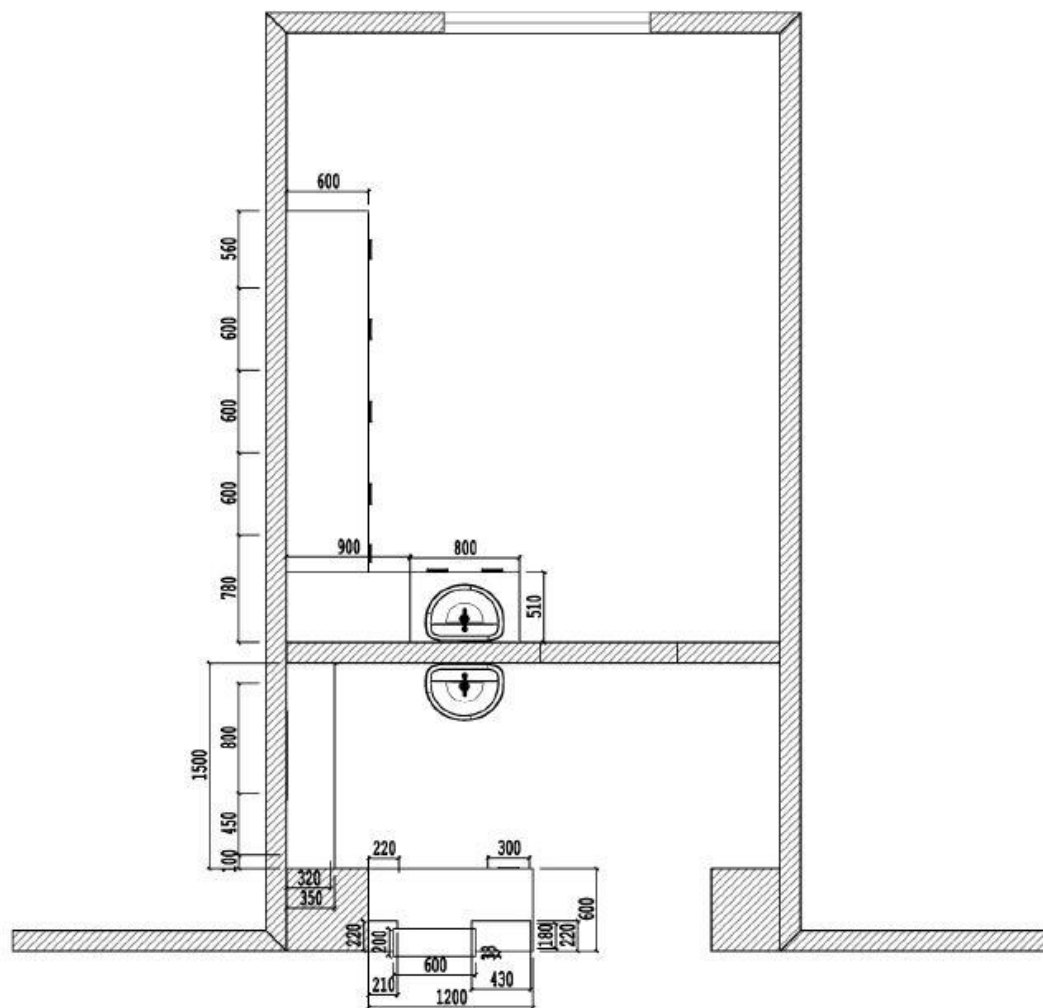

Rys.19

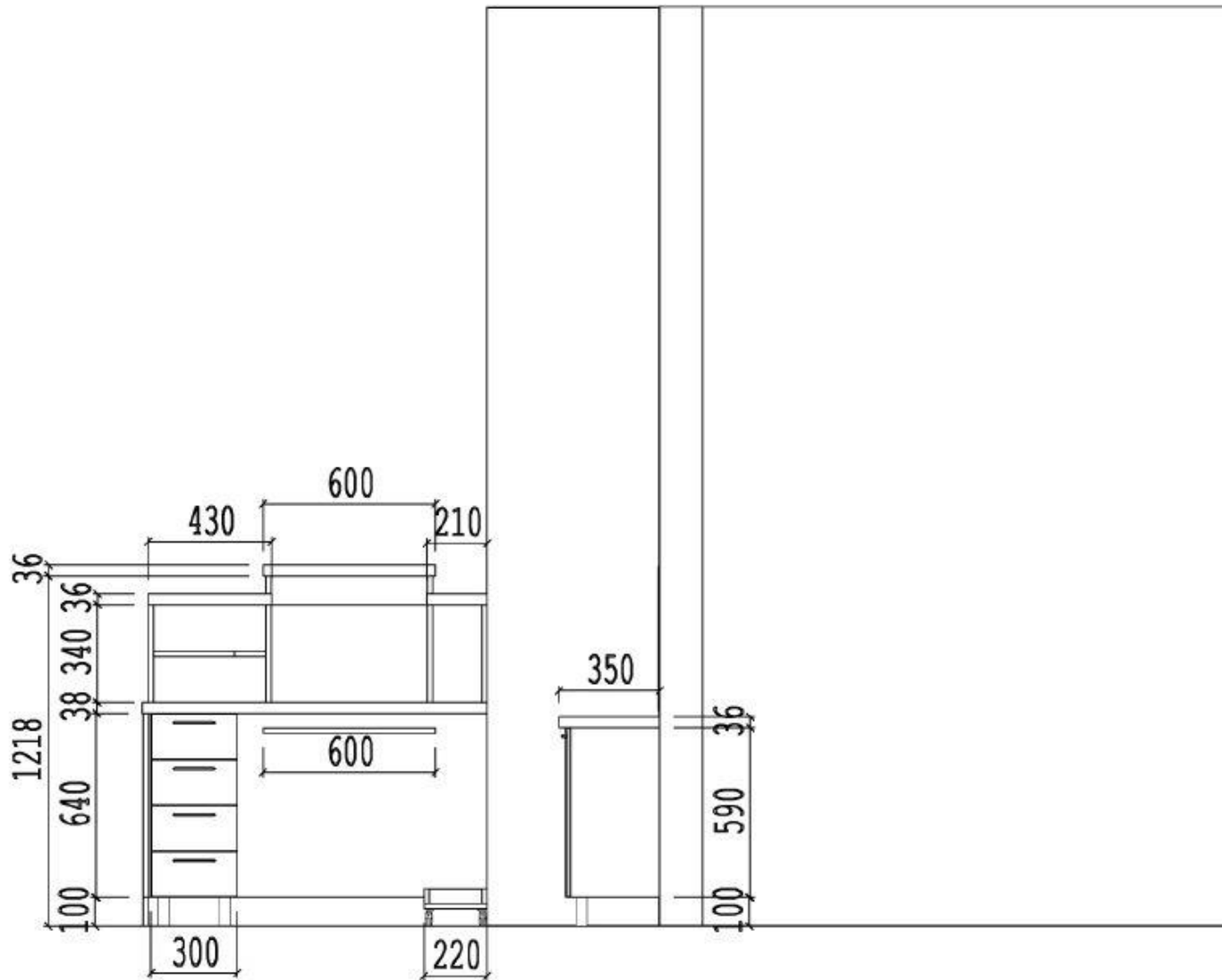

Rys.20

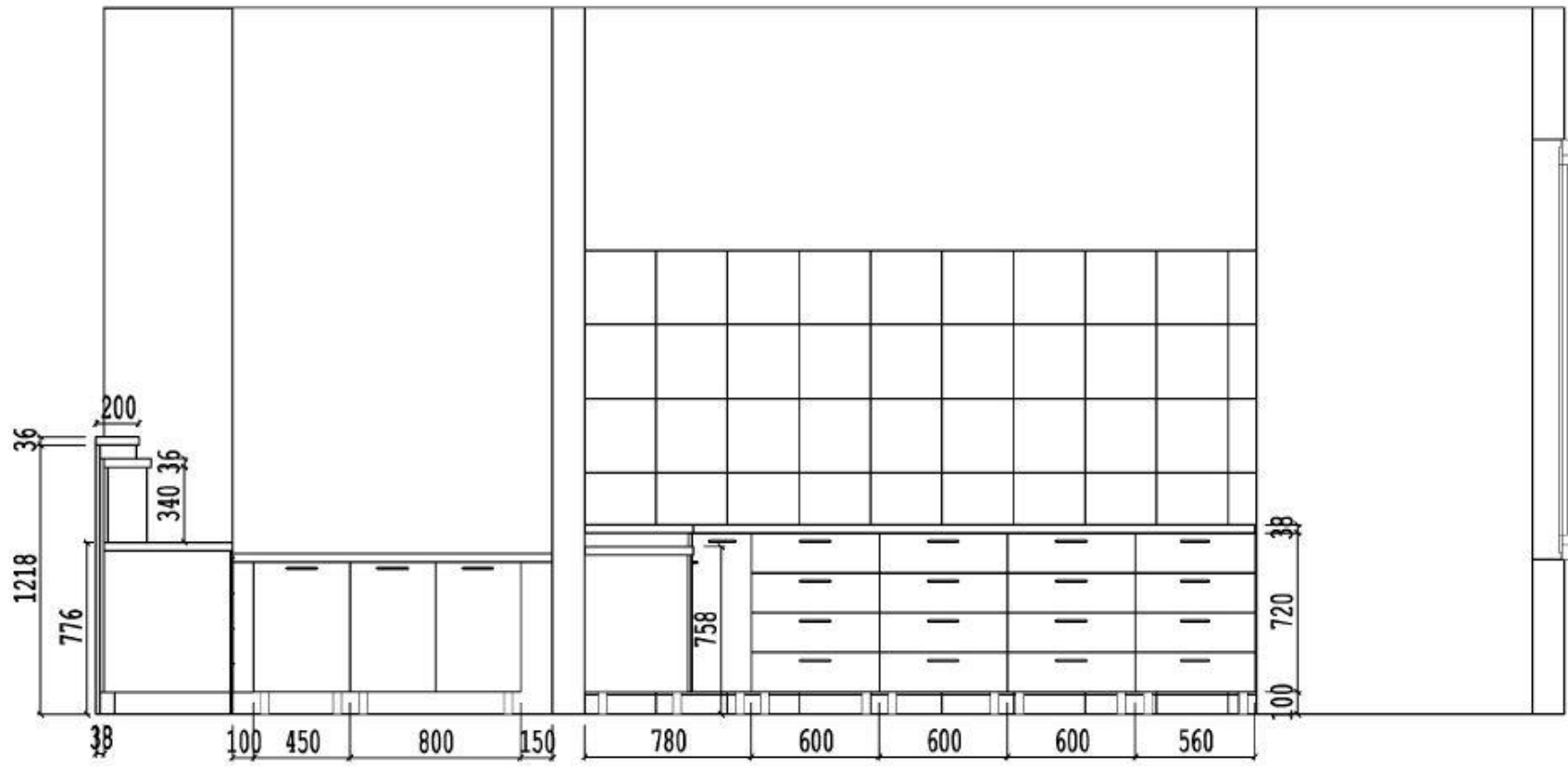

Rys.21

9. Sekretariat

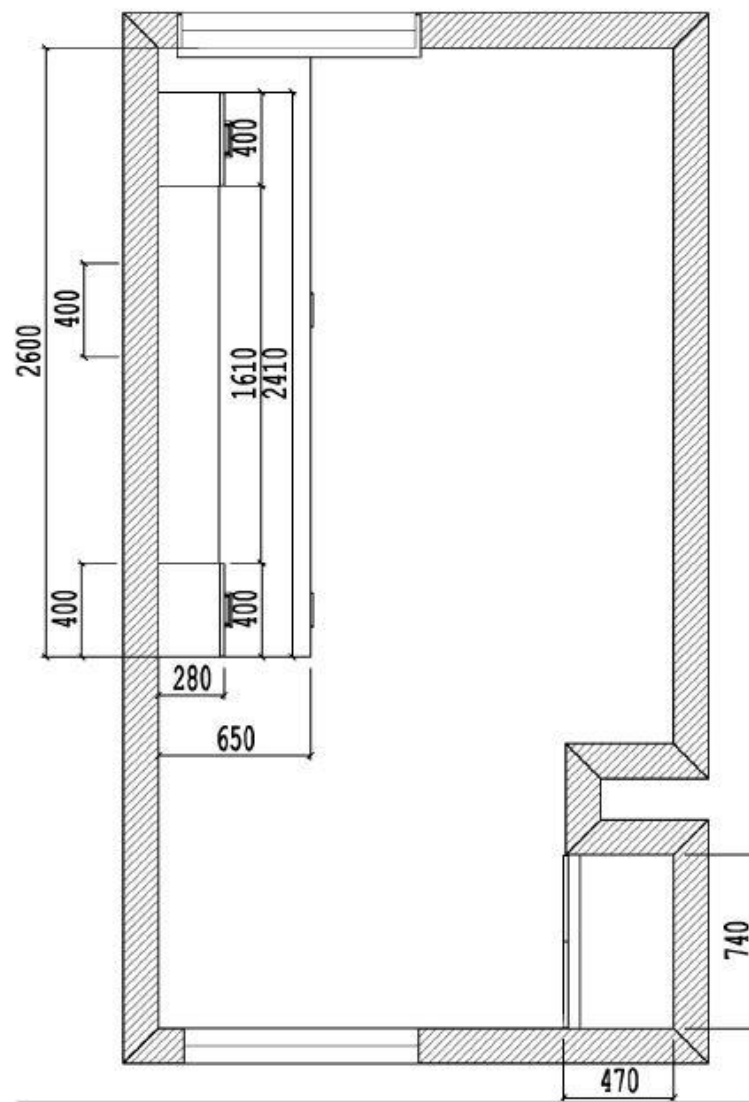

Rys.22

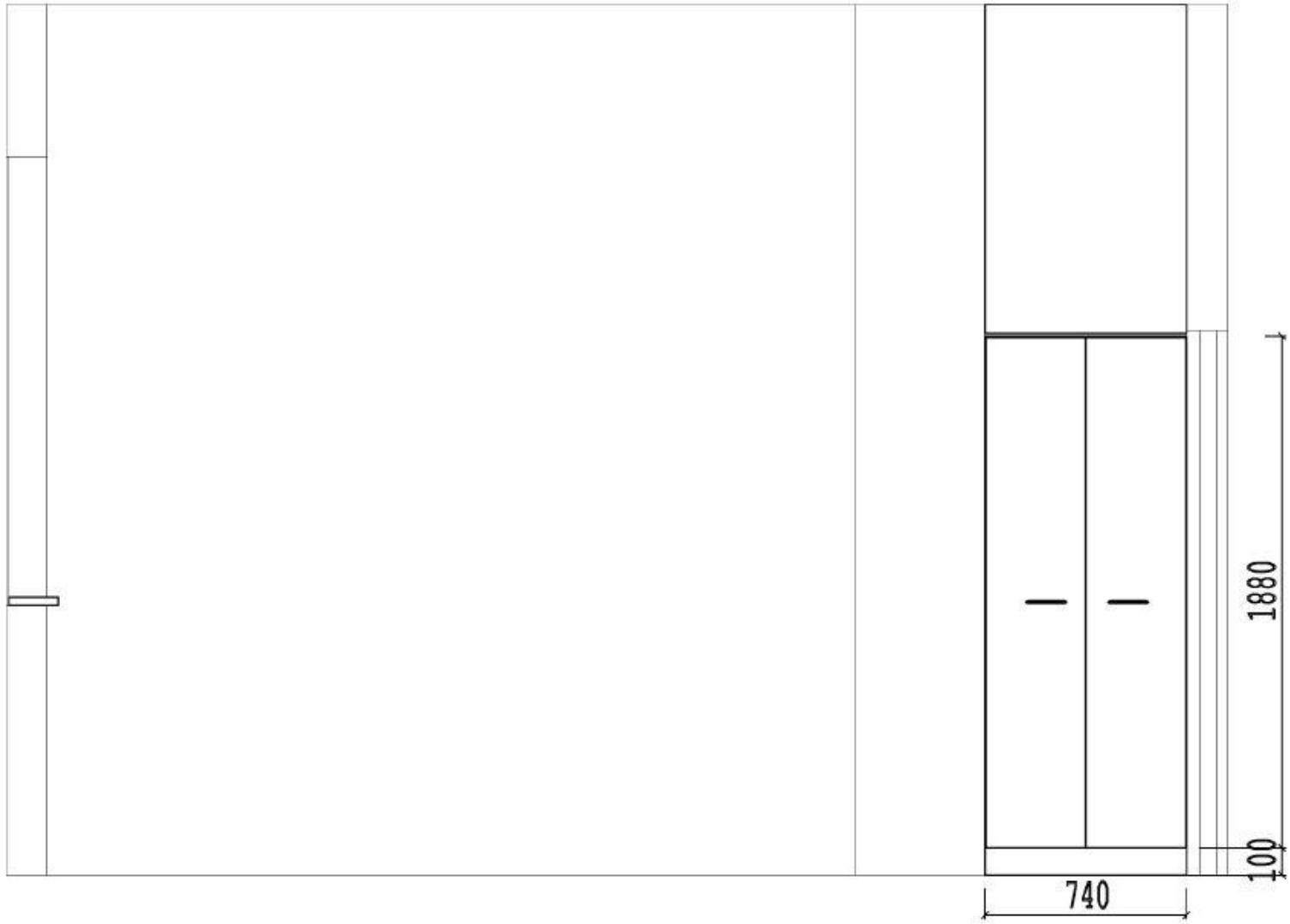

Rys.23

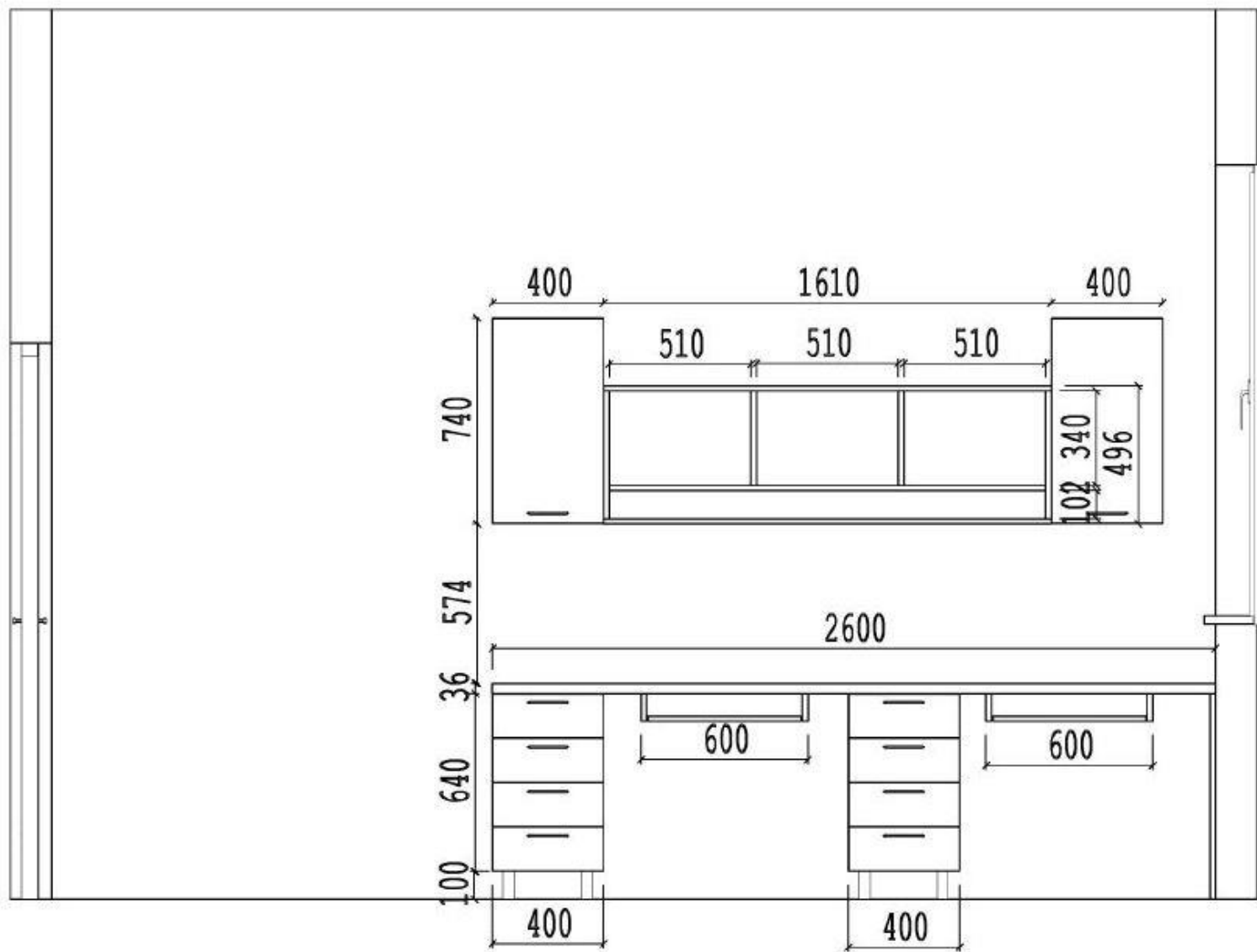

Rys.24

10. Szafa

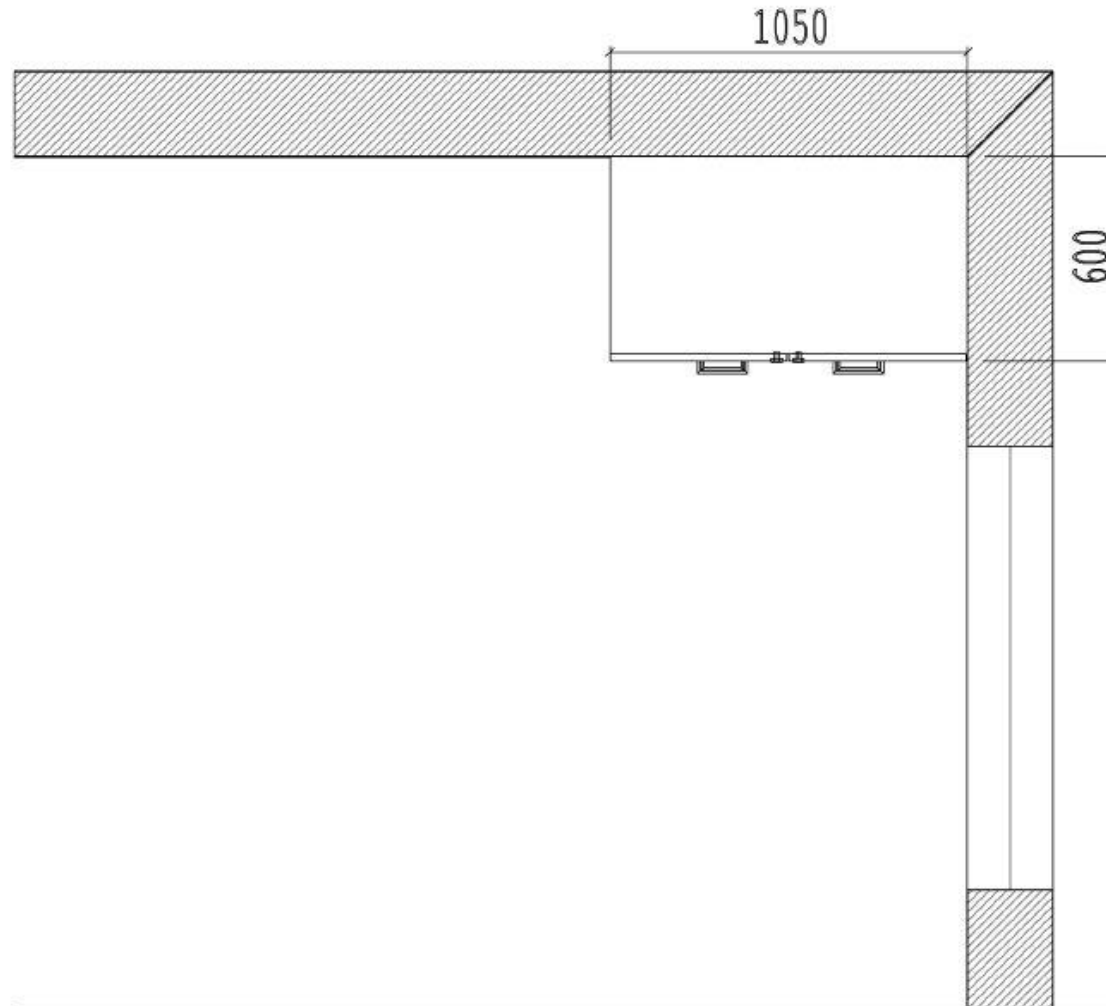

Rys.25

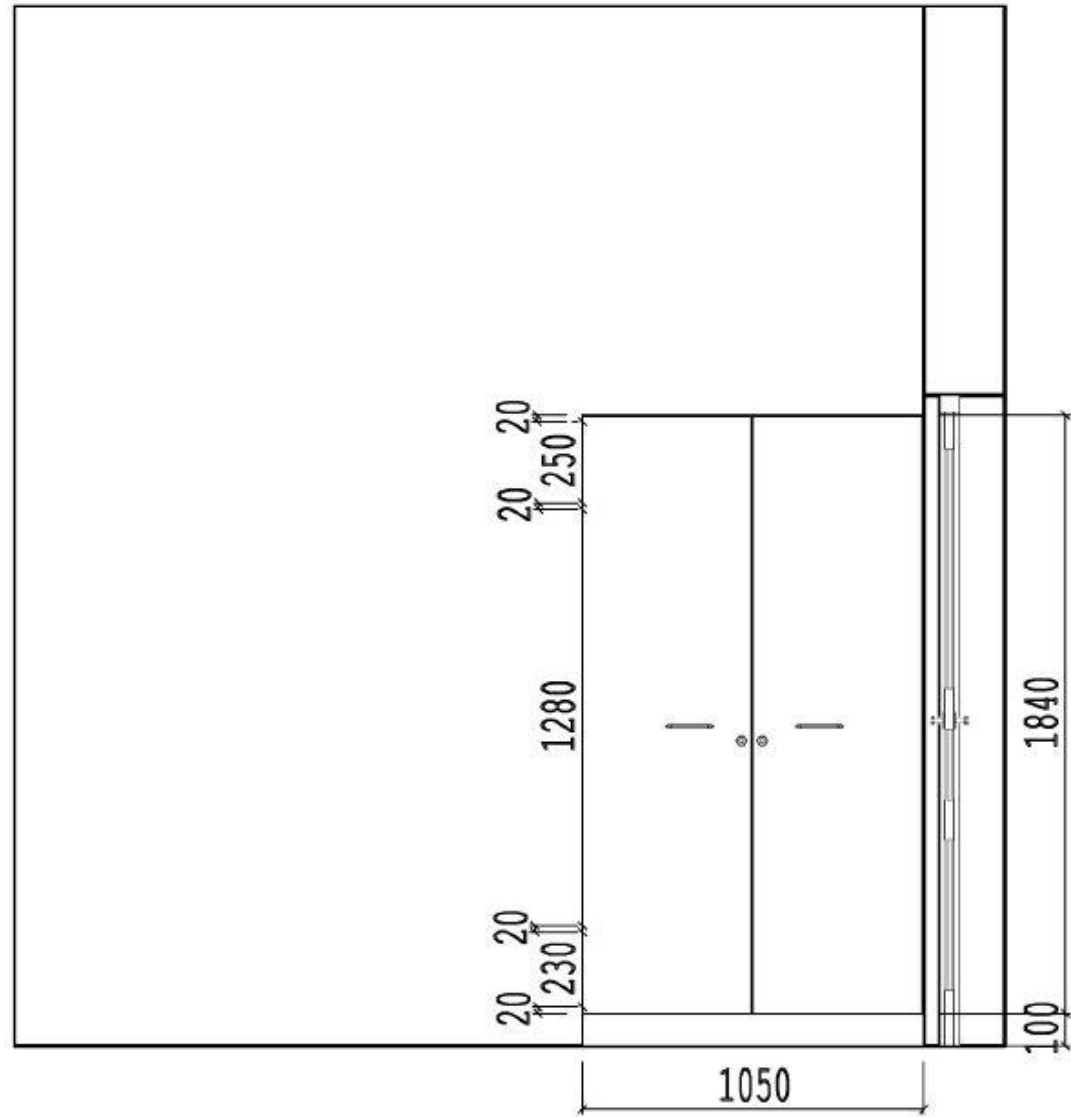

Rys.26

11. Szatnia

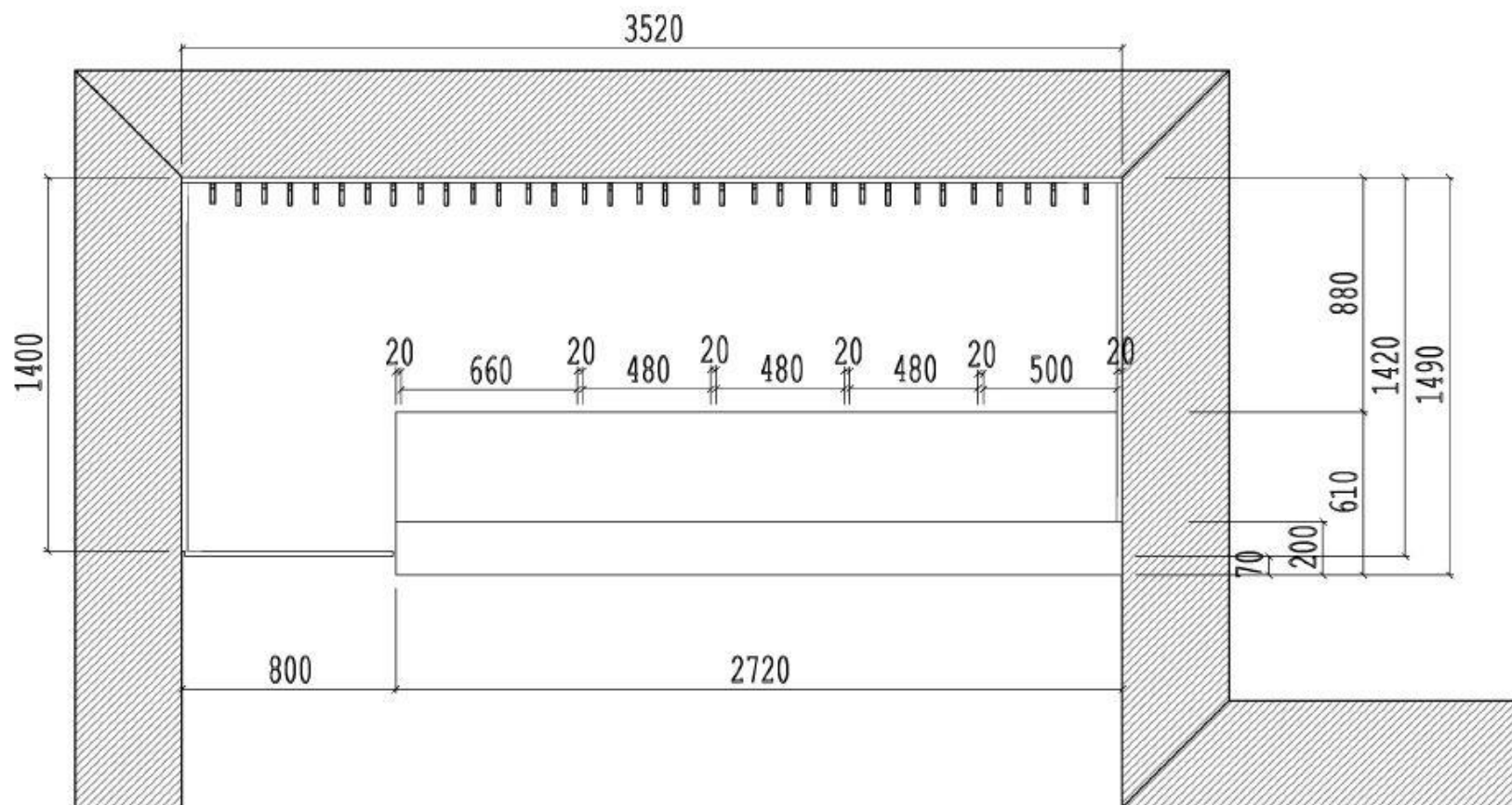

Rys.27



Rys.28

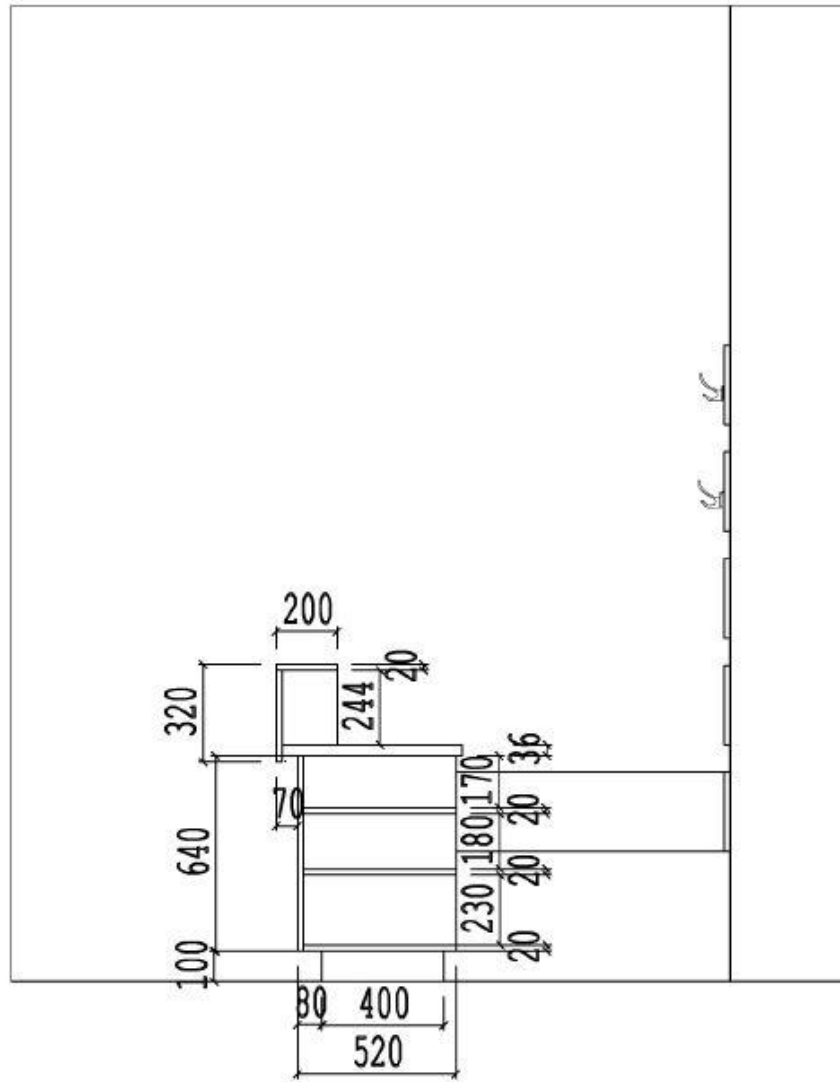

Rys.29